

FRAME:	HP:	RPM:	PHASE:	VOLT:	ENCL:	FREQ:	FLA:	LRA:
--------	-----	------	--------	-------	-------	-------	------	------

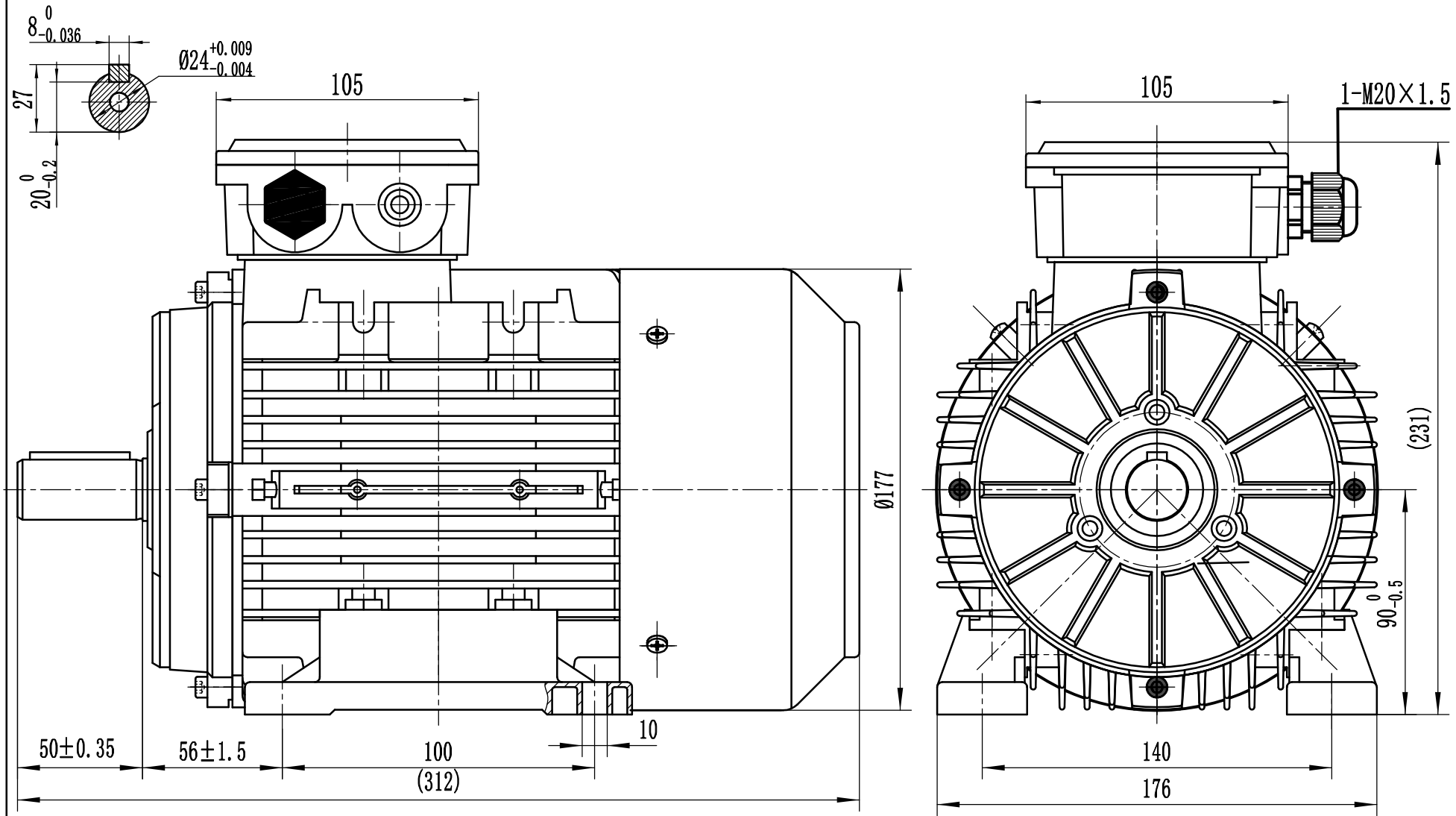

	MODEL:	TA90S B3	SCALE:	DATE:	UNITS:
	REV.DESC:		VERSION:	REVISED:	BY:
	WWW.TECHTOP.COM				